

GLAST LAT I&T

*GLAST Monthly
Mission Review
Dec 1, 2005*



Monthly Mission Review

LAT Environmental Test Planning

December 1, 2005

W Neil Johnson
neil.johnson@nrl.navy.mil

Martin Nordby
nordby@slac.stanford.edu

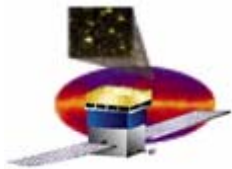

GLAST LAT I&T

Environmental Test: Plan-Level Documents and Status

GLAST Monthly
Mission Review
Dec 1, 2005

Document	Title	Status	ECD
LAT-MD-02717-01	LAT Environmental Test Sequence		Released
LAT-MD-01196-03	LAT Dynamics Test Plan		Released 10/28
LAT-MD-00276-02	LAT EMI/EMC Test Plan		Released 10/28
LAT-MD-01600-03	LAT Thermal-Vacuum Test Plan		Released 10/28
LAT-SS-06640-01	LAT Environmental Test MGSE/STE Requirements		Released 9/30
LAT-PS-06898-01	LAT Environmental Test Implementation Plan	Final draft in work	
LAT-MD-06560-01	Plan for Integrating and Testing the LAT on the Observatory	No progress, content being transferred to SpecAstro ICD ICN-099	
TBD	LAT Environmental Test Pathfinding	2 nd draft in review.	

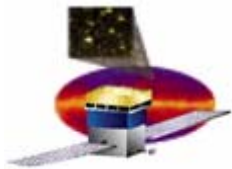

GLAST LAT I&T

Environmental Test: Configuration Drawings and Status

GLAST Monthly
Mission Review
Dec 1, 2005

Drawing	Title	Status	ECD
LAT-DS-06188	Acoustic Test Configuration Assembly	In release cycle (11/22)	Early Dec
LAT-DS-06185	Thermal-Vacuum Test Configuration Assembly	3 rd draft out for review	Mid Dec
LAT-DS-06187	Horizontal Vibration Test Configuration Assembly	2 nd draft in check	Early Dec
LAT-DS-06190	Vertical Vibration Test Configuration Assembly	2 nd draft in check	Early Dec
LAT-DS-06186	Handling Configuration Assembly	In release cycle (11/22)	Early Dec
LAT-DS-06184	Transport Configuration Assembly	Waiting Transport Container final design	Early Dec
LAT-DS-06189	EMI/EMC Test Configuration Assembly	2 nd draft in work	Mid Dec
LAT-DS-06191	Mass Properties Configuration Assembly	Not Started	Mid Jan

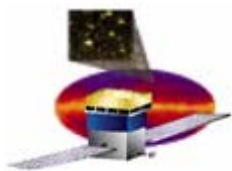

Environmental Test Sequence

LAT-MD-02717-01, "LAT Environmental Test Sequence" Release 9 May 2005

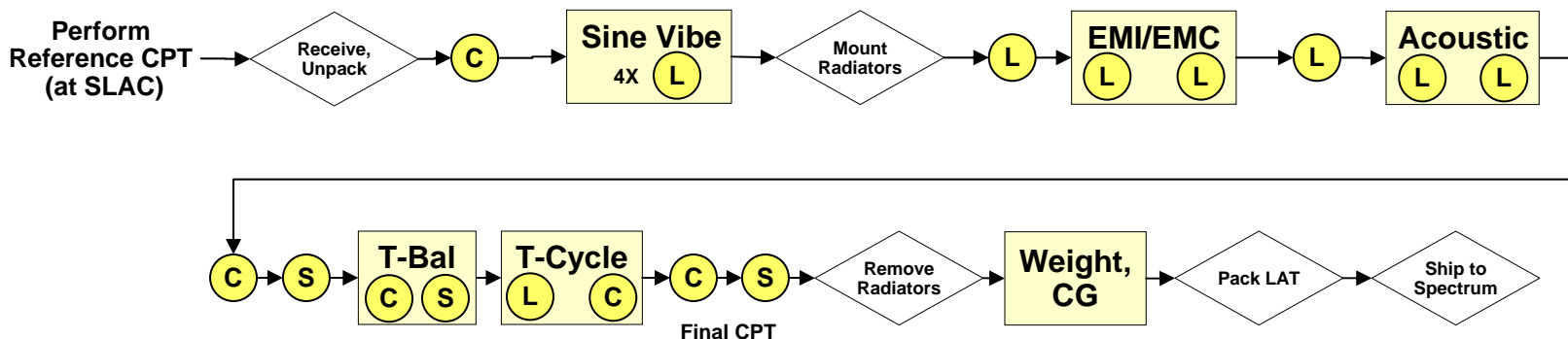

- (L)** Limited Performance
- (C)** Comprehensive Performance
- (S)** SVAC Test

Updated LAT Environmental Test Sequence

No change from last month

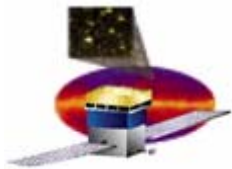

Environmental Test MGSE/STE

- ❑ **Transport Container**
 - In manufacture – ECD: 12/23
 - Completing analyses
 - Assembly and proof test – ECD: 1/08/06
- ❑ **Test Interface Plate**
 - Complete and in use
- ❑ **Test Stand/Spreader Bars**
 - In fabrication at Allied Engineering—ECD: 12/20
- ❑ **T-Vac Sink Plates and Cal-Rod Cage**
 - Radiator Heater Cage Assembly: in fabrication at NRL, ECD 1/13/06
 - ACD Sink Plate Assembly, SC Simulator Plate : awaiting release, ECD 12/02, fab complete 1/30/06
- ❑ **Acoustic Simulator**
 - Release and fabrication of test plate, ECD: 1/26/06
- ❑ **Mass Properties Plate**
 - Not started

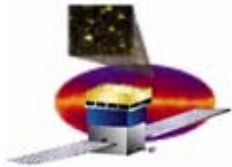

Facilities

- ❑ **Thermal Vacuum Test**
 - Cables and Port Plates – complete
 - Trolley (cart) – in manufacture. ECD: 12/16
 - Chamber rail supports – analysis complete 12/2, fab complete 1/09/06
 - Chamber rails – in fabrication, ECD 1/10/06
- ❑ **Acoustic Test**
 - Ramp manufacture: ECD 1/09/06
- ❑ **Vibration Test**
 - Expander head load frame - in procurement process, fab/proof ECD 2/03/06
- ❑ **EMI/EMC Test**
 - Ramp manufacture: ECD 1/26/06

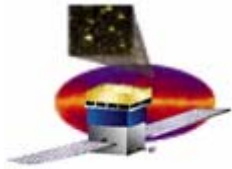

Issues and Concerns

- ❑ **Schedule compression – path finding, TCS checkout, LAT delivery**
- ❑ **GSFC-provided Vertical Lift Fixture**
 - **Use of VLF in LAT testing has been rejected**
 - Late delivery of VLF and completion state of current planning / configuration drawings precludes use.
 - **Pathfinding test lift with VLF, late in environmental test program at NRL, is under consideration.**
 - Serial test → schedule impact.
 - **Minimization of involvement with VLF seems prudent.**